

# Jugo outdoor collection

Dimensions



SPECIFICATIONS AND TECHNICAL DRAWING

STRUCTURE	metal tube $\varnothing 16$ mm + powder coating (3seater)
BASE	metal tube $\varnothing 16$ mm + powder coating
SEAT & BACKREST	inox plate + powder coating
ARMRESTS	solid wood + outdoor oil
CUSHION	waterproof fabric (removable)

[sofa information website](#)

[armchair information website](#)

[sunlounger information website](#)

[chair & barstool information website](#)

**ARMCHAIR**  
dimensions 84 x 79 x 64 cm  
w 33" x d 31" x h 25 1/4"

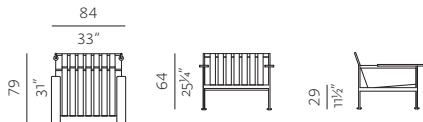

**LOUNGE ARMCHAIR**  
dimensions 74 x 94 x 72 cm  
w 29 1/4" x d 37" x h 28 1/4"

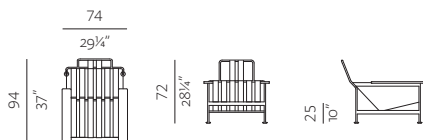

**3SEATER**  
dimensions 213 x 79 x 64 cm  
w 83 3/4" x d 31" x h 25 1/4"

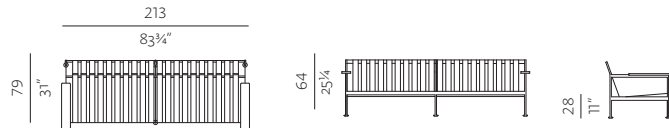

**SUNLOUNGER**  
dimensions 210 x 76 x 29 cm  
w 82 3/4" x d 30" x h 11 1/2"

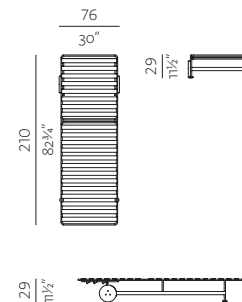

**SUNLOUNGER + ARMRESTS**  
dimensions 210 x 98 x 51 cm  
w 82 3/4" x d 38 3/4" x h 25 1/4"

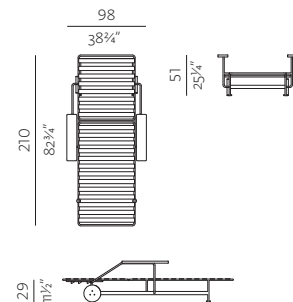

**SUNLOUNGER + ARMREST (L/R)**  
dimensions 87 x 210 x 29 cm  
w 82 3/4" x d 34 1/4" x h 25 1/4"

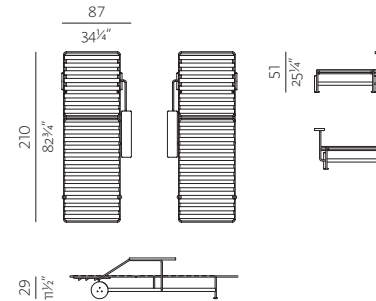

**CHAIR**  
dimensions 54 x 55 x 80 cm  
w 21 1/4" x d 21 3/4" x h 31 3/4"

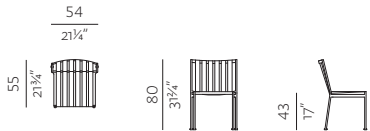

**CHAIR + METAL ARMRESTS**  
dimensions 60 x 55 x 80 cm  
w 23 3/4" x d 21 3/4" x h 31 3/4"

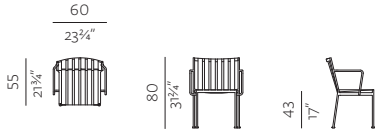

**CHAIR + WOODEN ARMRESTS**  
dimensions 60 x 56 x 80 cm  
w 23 3/4" x d 21 3/4" x h 31 3/4"

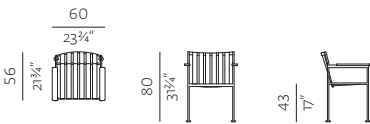

**BARSTOOL**  
dimensions 47 x 49 x 97 cm  
w 18 3/4" x d 19 1/4" x h 38 3/4"

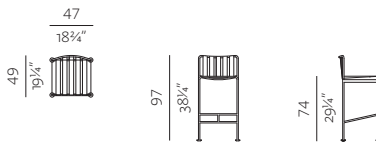

SPECIFICATIONS AND TECHNICAL DRAWING

STRUCTURE	metal tube $\varnothing 25$ mm + inox plate + powder coating (tables)
TABLE TOP	inox slats + powder coating / solid wood slats + outdoor lacquer

table information website

low table information website

**TABLE**  
dimensions 83 x 83 x 75 cm  
w 31 $\frac{3}{4}$ " x d 31 $\frac{3}{4}$ " x h 29 $\frac{3}{4}$ "

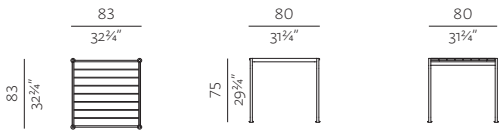

**LOW TABLE**  
dimensions 95 x 95 x 40 cm  
w 37 $\frac{3}{4}$ " x d 37 $\frac{3}{4}$ " x h 15 $\frac{3}{4}$ "

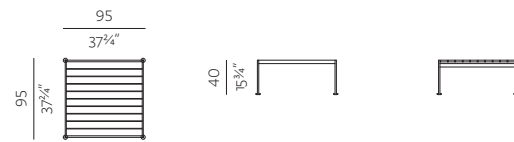

STRUCTURE	metal + powder coating
TABLE TOP	inox plate + powder coating

side table information website

**SIDE TABLE**  
dimensions 45 x 54 x 40 cm  
w 17 $\frac{3}{4}$ " x d 21 $\frac{1}{4}$ " x h 15 $\frac{3}{4}$ "

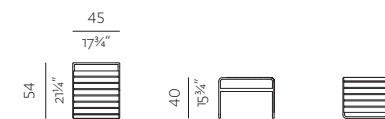

**TABLE**  
dimensions 143 x 83 x 75 cm  
w 56 $\frac{1}{4}$ " x d 32 $\frac{3}{4}$ " x h 29 $\frac{3}{4}$ "

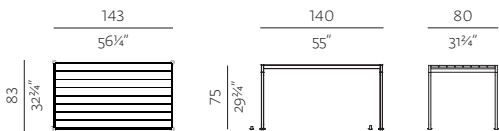

**TABLE EXTENSION**  
dimensions 50 (37) x 75 x 4 cm  
w 19 $\frac{3}{4}$ " (14 $\frac{3}{4}$ ") x d 29 $\frac{3}{4}$ " x h 1 $\frac{1}{4}$ "

